

## LAMPIRAN

No.	Nama Ruang	Perabot	Jumlah Perabot	Sumber	Kapasitas	Jumlah ruang	Luas (m <sup>2</sup> )	Total Luas (m <sup>2</sup> )
Area penginapan								
1.	Suite Room	King size bed (180 x 200 cm)	1	SBR	3 orang	3	52 m <sup>2</sup>	156 m <sup>2</sup>
		Meja nakas	2					
		Lemari pakaian	1					
		Set mini pantry	1					
		Sofa	2					
		Meja	1					
		Meja dan kursi kerja set	1					
		Televisi	1					
		AC	1					
	Kamar mandi	Closet duduk						
Shower								
Bathtub								
Wastafel								
2.	Deluxe room	Queen size bed (160 x 200 cm)	1	SBR	2 orang	4	39 m <sup>2</sup>	156 m <sup>2</sup>
		Meja nakas	2					
		Lemari pakaian	1					
		Set mini pantry	1					
		Televisi	1					
		AC	1					
	Kamar mandi	Closet duduk	1					
		Shower	1					
		Bathtub	1					
		Wastafel	1					
3.	Standard room			SBR	1 orang	4	30 m <sup>2</sup>	120 m <sup>2</sup>
		Single room	Double size bed (120 x 200 cm)					
		Meja nakas	2					
		Lemari pakaian	1					
		Televisi	1					
		AC	1					
	Kamar mandi	Closet duduk	1					
		Shower	1					
		Wastafel	1					
	Twin Room	Single bed (90 x 200 cm)	2					
		Meja nakas	2					
		Lemari pakaian	1					
		Televisi	1					
		AC	1					
	Kamar mandi	Closet duduk	1					
		Shower	1					
Wastafel		1						
Double room	Queen size bed (160 x 200 cm)	1						
	Meja nakas	2						
	Lemari pakaian	1						
	Televisi	1						
	AC	1						
Kamar mandi	Closet duduk	1						
	Shower	1						
	Wastafel	1						
<b>TOTAL</b>				<b>Sirkulasi 20-30% (+30%)</b>			<b>912,6 m<sup>2</sup></b>	

Area penunjang													
1.	Meeting room	Meja	10	SBR	20 orang	1	77 m <sup>2</sup>	77 m <sup>2</sup>					
		Kursi	20										
		Proyektor	1										
2.	Restoran	Meja	7	SBR	24 orang	1	192 m <sup>2</sup>	192 m <sup>2</sup>					
		Kursi	10										
		Wastafel	2										
		Dapur	Working table						1				
	Kitchen sink	1											
	Oven	1											
	Stove	2											
	Lemari perlengkapan	1											
	Rak bumbu	1											
	Meja saji	1											
	Coffee shop	Meja bar	2						SBR	10 orang	1		
	Mesin kopi	3											
	Wastafel	1											
Tempat makan tepi pantai	Meja makan	10	SBR	37 orang	1	150 m <sup>2</sup>	150 m <sup>2</sup>						
	Kursi makan	32											
	Kursi Pantai (sun lounge)	4											
	Meja	3											
3.	Lapangan Voli Pantai	Net	2	SNI	4 orang	2	128 m <sup>2</sup>	356 m <sup>2</sup>					
4.	Kolam renang		1	NAD	1 unit	1	45 m <sup>2</sup>	45 m <sup>2</sup>					
5.	Taman dan jogging track		1		1 unit	1	30 m <sup>2</sup>	30 m <sup>2</sup>					
6.	Playground	Alat bermain	1	SBR	1 unit	1	50 m <sup>2</sup>	50 m <sup>2</sup>					
7.	Mushola		1	SBR	11 orang	1	19 m <sup>2</sup>	19 m <sup>2</sup>					
8.	Toilet umum	Closet duduk	1	PERMEN	2 orang	2	1,7 m <sup>2</sup>	3,4 m <sup>2</sup>					
		Wastafel	1	PERMEN	2 orang	2	1,7 m <sup>2</sup>	3,4 m <sup>2</sup>					
9.	R. Pagelaran wayang	Gamelan	1	SBR	89 orang	1	138 m <sup>2</sup>	138 m <sup>2</sup>					
<b>TOTAL</b>			<b>Sirkulasi 20-30% (+30%)</b>				<b>1382 m<sup>2</sup></b>						
Area pengelola													
1.	R. kepala	Meja dan kursi kerja	1	HD	3 orang	1	20 m <sup>2</sup>	20 m <sup>2</sup>					
		Lemari buku	1										
		Loker	1										
		Kursi tamu	2										
2.	R. Administrasi	Meja dan kursi kerja	2	HD	2 orang	1	12 m <sup>2</sup>	12 m <sup>2</sup>					
		loker	1										
3.	R. staff	Meja dan kursi kerja	10	HD	10 orang	1	40 m <sup>2</sup>	40 m <sup>2</sup>					
		Loker	4										
4.	R. rapat	Meja rapat	4	HD	15 orang	1	56 m <sup>2</sup>	56 m <sup>2</sup>					
		Kursi rapat	15										
5.	R. tamu	Sofa	2	HD	4 orang	1	17 m <sup>2</sup>	17 m <sup>2</sup>					
		meja	1										
6.	Resepsionis	Meja	1	HD	2 orang	1	15,75 m <sup>2</sup>	15,75 m <sup>2</sup>					
		Kursi	2										
7.	Pantry	Set pantry	1	HD	3 orang	1	3,2 m <sup>2</sup>	3,2 m <sup>2</sup>					
8.	Toilet	Closet duduk	3	PERMEN	6 orang	2	1,7 m <sup>2</sup>	3,4 m <sup>2</sup>					
		Wastafel	2										
<b>TOTAL</b>			<b>Sirkulasi 20-30% (+30%)</b>				<b>217,56 m<sup>2</sup></b>						
Area servis													
1.	Lobby		1	SBR	6 orang	1	1,62 m <sup>2</sup>	9,72 m <sup>2</sup>					
2.	Ruang tunggu	Sofa	4	SBR	8 orang	1	24 m <sup>2</sup>	24 m <sup>2</sup>					
		Meja	2										

3.	Housekeeping	Rak perlengkapan		TSS	10 orang	1	14 m <sup>2</sup>	14 m <sup>2</sup>
	Laundry	Mesin cuci	4	TSS	4 orang	1	12,6 m <sup>2</sup>	12,6 m <sup>2</sup>
		Meja setrika	4					
		Lemari baju	3					
	Lemari perlengkapan	2						
4.	Gudang	Lemari barang	1	SBR	2 orang	2	9 m <sup>2</sup>	18 m <sup>2</sup>
5.	Parkir							
	Motor		30	NAD	30 motor	30	2 m <sup>2</sup>	60 m <sup>2</sup>
	Mobil		20	NAD	30 mobil	20	12,5 m <sup>2</sup>	250 m <sup>2</sup>
6.	R. security	Meja	2	SBR	4 orang	1	16 m <sup>2</sup>	16 m <sup>2</sup>
		Kursi	4					
		Monitor pantau	3					
		Rak barang	1					
7.	Ruang panel		1	SBR	2 orang	1	16 m <sup>2</sup>	16 m <sup>2</sup>
8.	Ruang pompa		1	HRP	2 orang	1	25 m <sup>2</sup>	25 m <sup>2</sup>
9.	Ruang genset		1	HRP	1 orang	1	25 m <sup>2</sup>	25 m <sup>2</sup>
<b>TOTAL</b>				<b>Sirkulasi 20-30% (+30%)</b>			<b>611,42 m<sup>2</sup></b>	
<b>TOTAL KESELURUHAN</b>							<b>3123,6 m<sup>2</sup></b>	

Keterangan :

SBR : Studi Besaran Ruang

NAD : "Data Arsitek" by Ernst Neufert, Jakarta: Erlangga (2002)

PERMEN : Peraturan Menteri Pekerjaan Umum dan Perumahan Rakyat RI No. 14/PRT/M2017

HD : "*Human Dimension*" by Julius Pameroy & Martin, New York (1979)

TSS : "Time Saver Standards for Building Types 2<sup>nd</sup> Edition" by Joseph De Chiara & John Callender (1983)

SNI : Standar Nasional dan Internasional

#### DIMENSI RUANG DALAM (ANALISIS STUDI RUANG)

Nama Ruang	Ukuran Ruang	Luas
------------	--------------	------

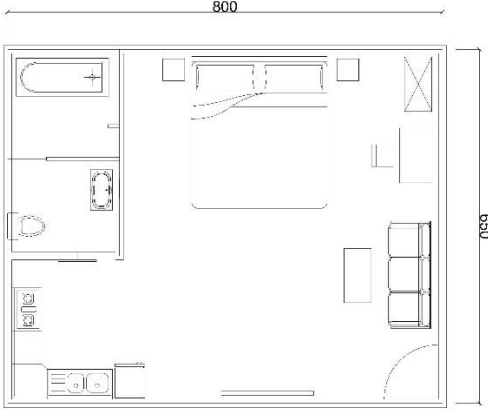
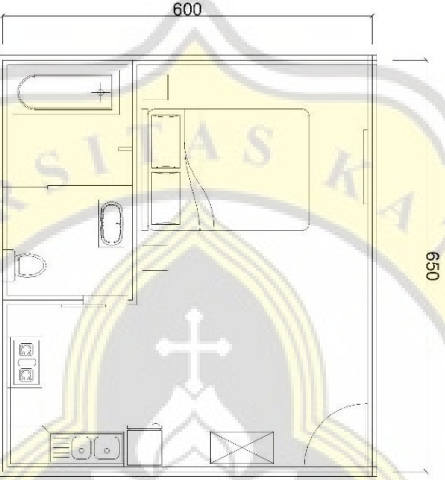
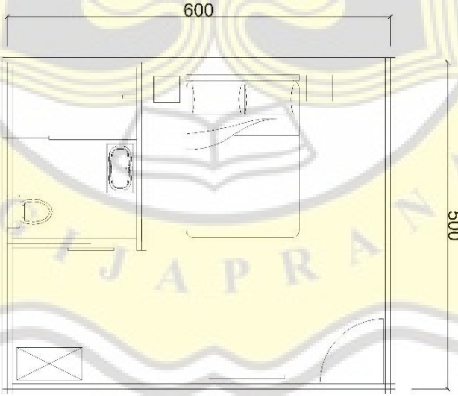
Suite room		$L = 8 \times 6,5 = 52 \text{ m}^2$
Deluxe room		$L = 6 \times 6,5 = 39 \text{ m}^2$
Standard room		
Single room		$L = 6 \times 5 = 30 \text{ m}^2$

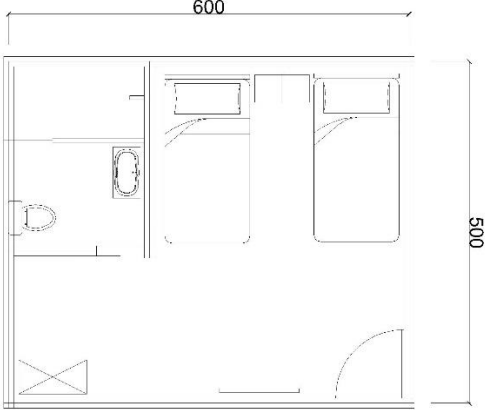
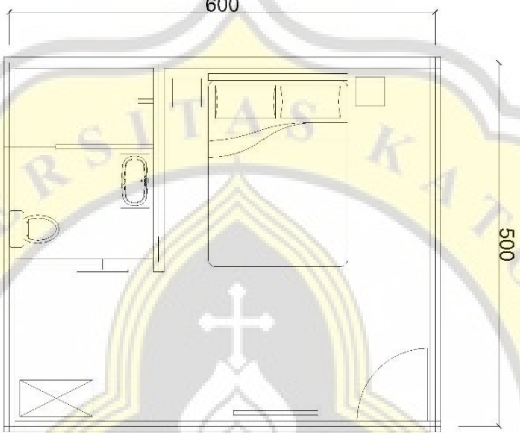
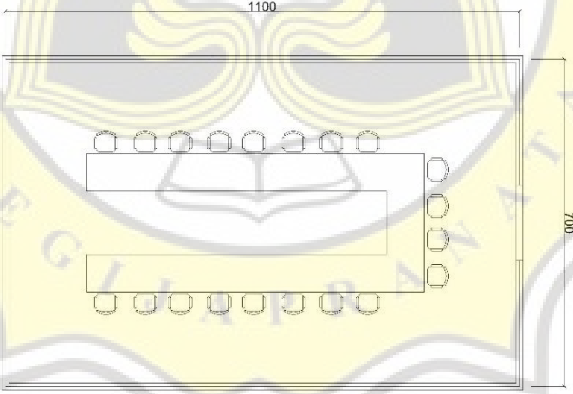
Twin room		$L = 6 \times 5 = 30$ $m^2$
Double room		$L = 6 \times 5 = 30$ $m^2$
Meeting room		$L = 11 \times 7 =$ $77 m^2$

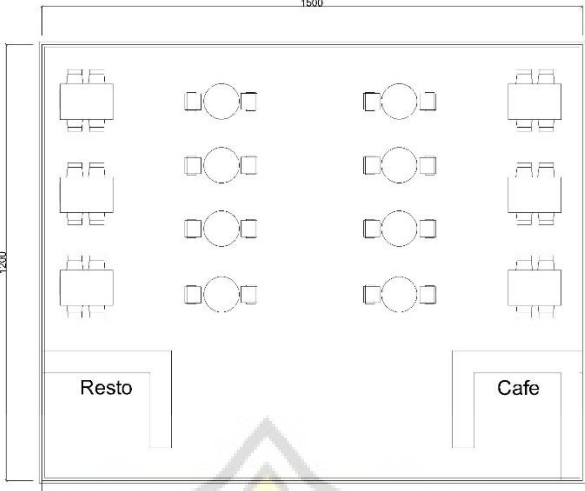
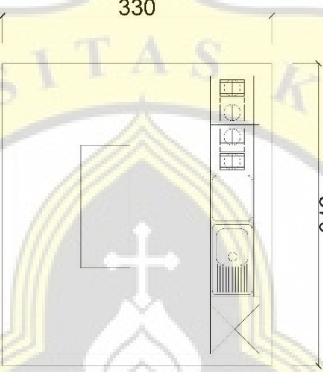
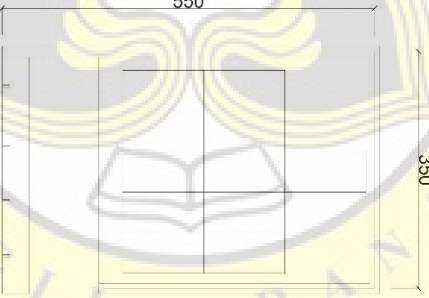
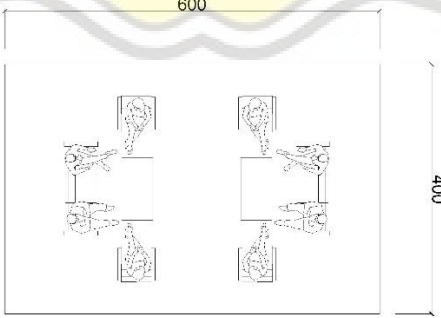
Resto dan Cafe		$L = 15 \times 12 = 180 \text{ m}^2$
Dapur		$L = 3,3 \times 3,7 = 12,21 \text{ m}^2$
Mushola		$L = 5,5 \times 3,5 = 19,25 \text{ m}^2$
R. Tunggu		$L = 6 \times 4 = 24 \text{ m}^2$

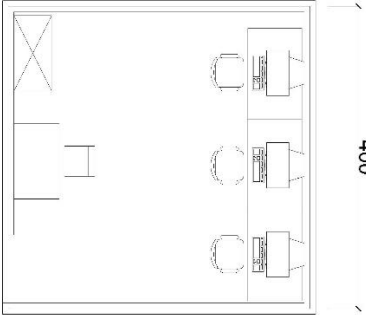
R. Security	 <p style="text-align: center;">400</p> <p style="text-align: right;">400</p>	$L = 4 \times 4 = 16$ $m^2$
-------------	---	-----------------------------



## Dimensi duduk normal

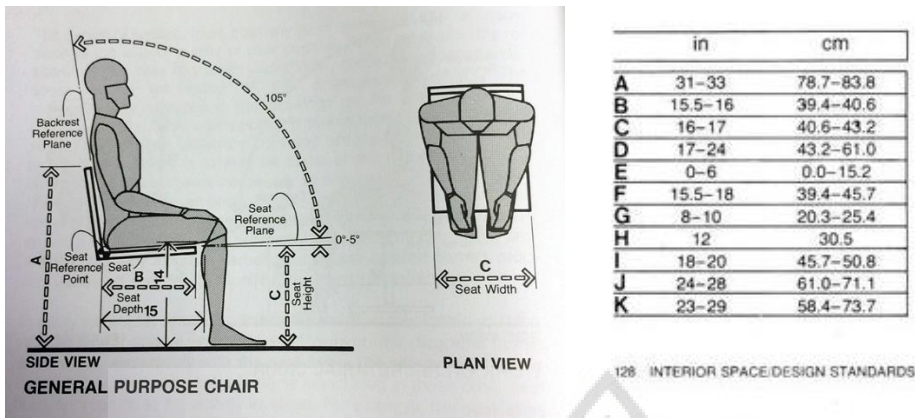

Sumber: Panero (2003). Human dimension

## Ukuran Lapangan Voli Pantai

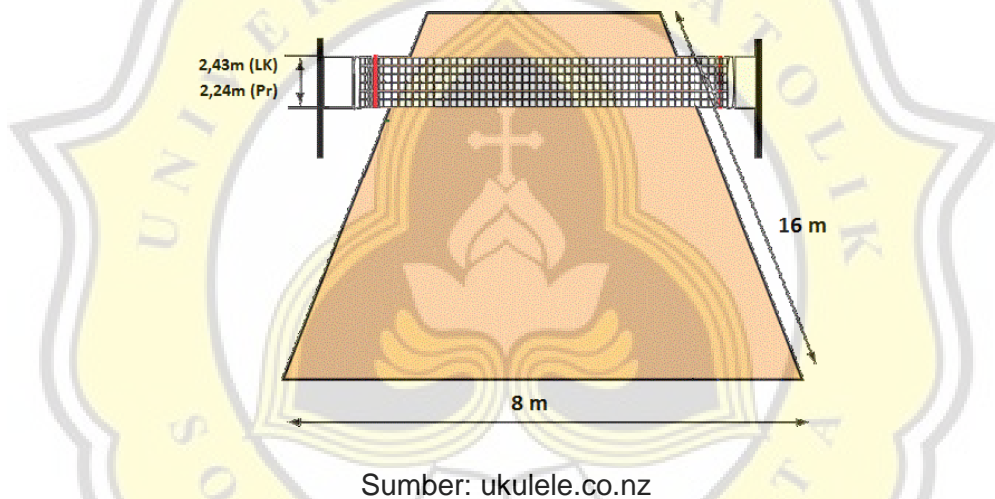

## Ukuran Kursi Pantai

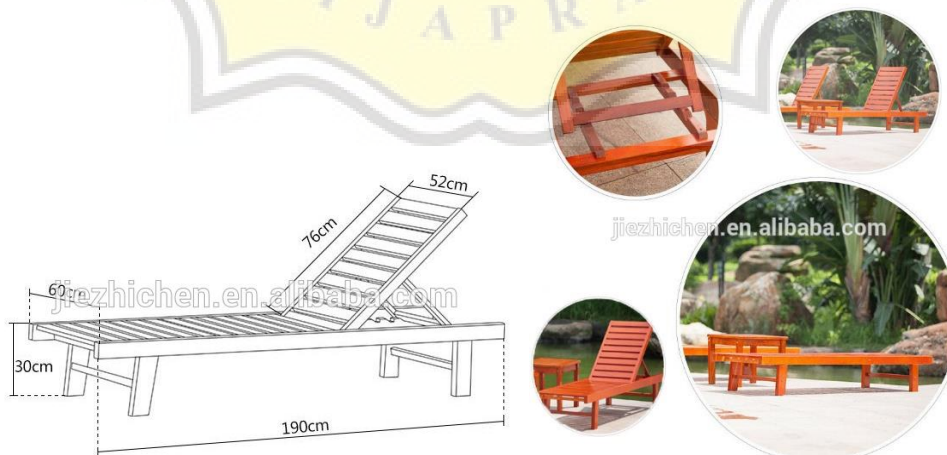



## Perangkat Gamelan

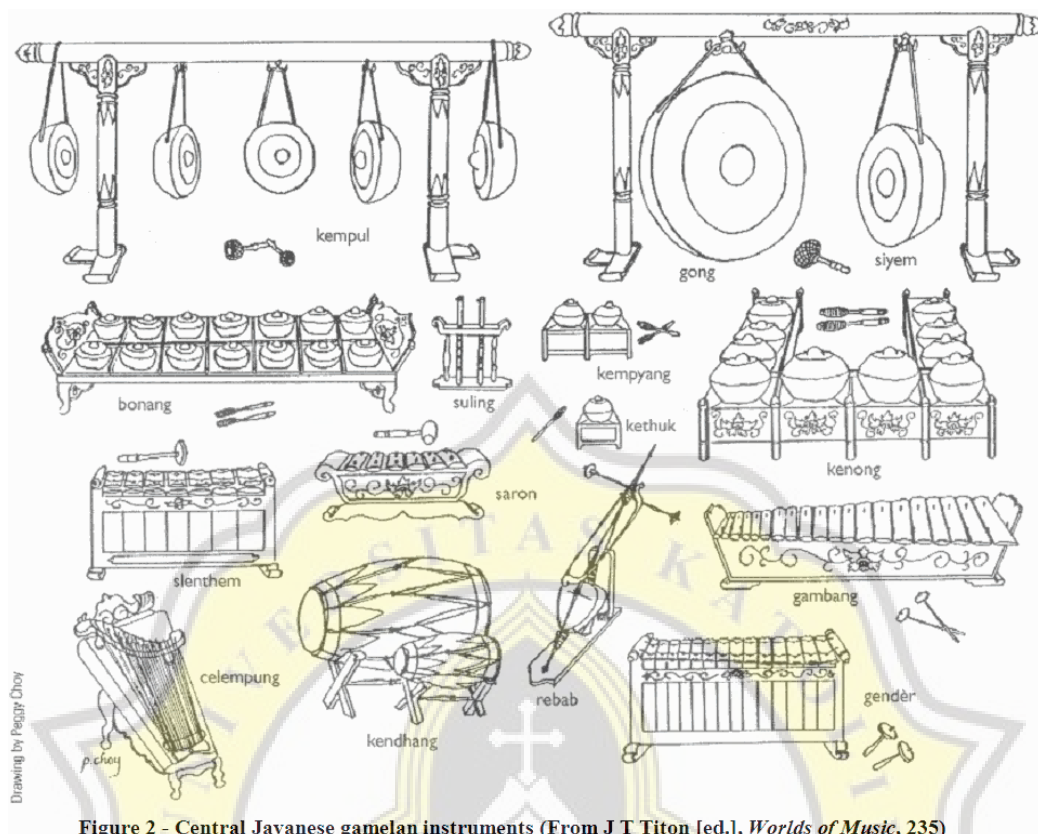

Sumber: yudhipri.wordpress.com



**9.74%** PLAGIARISM  
APPROXIMATELY

## Report #12922771

1. PENDAHULUAN Latar Belakang Kabupaten Gunungkidul memiliki potensi wisata yang cukup potensial dan beragam, mulai dari kekayaan alam berupa pantai, goa, bukit dan pegunungan, tempat bersejarah serta desa wisata budaya maupun wisata religi. Pengelolaan obyek wisata memberi keuntungan yang besar bagi Pemerintah, masyarakat dan dunia usaha. Pendapatan dari sektor sektor pariwisata yang berpengaruh secara langsung terkait dengan pembangunan pariwisata salah satunya adalah retribusi tempat penginapan. Dengan meningkatnya jumlah pengunjung akan berpengaruh pada meningkatnya jumlah pendapatan dari sektor pariwisata.

Dibawah ini merupakan data peningkatan pendapatan sektor pariwisata Kabupaten Gunungkidul tahun 2013 sampai dengan tahun 2017. Tabel 1. Pendapatan Sektor Pariwisata Kab.

Gunungkidul 2013-2017	Wisatawan Tahun 2013	2014	2015	2016	2017
Pajak hotel	42.987.911	56.512.620	236.626.223	377.692.366	716.245.584
Pajak restoran	1.339.666.031	2.014.769.578	2.837.757.051	4.504.005.100	5.204.844.586