

# LAMPIRAN

## 1. Ruang Tidur

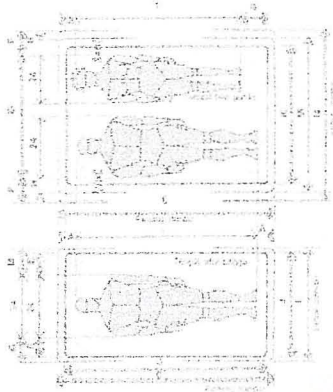

TEMPAT TIDUR TIDUR DAN GAYAN

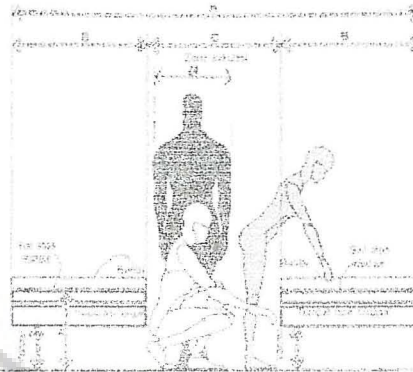

TEMPAT TIDUR KEMAS/BERBAGAI DIMENSI DAN JAVAN BERDIRI

No	Ukuran	Warna	Material
1	1,8 x 2,0	Putih	Kayu
2	1,5 x 2,0	Putih	Kayu
3	1,2 x 2,0	Putih	Kayu
4	1,0 x 2,0	Putih	Kayu
5	0,8 x 2,0	Putih	Kayu
6	0,6 x 2,0	Putih	Kayu
7	0,4 x 2,0	Putih	Kayu
8	0,2 x 2,0	Putih	Kayu

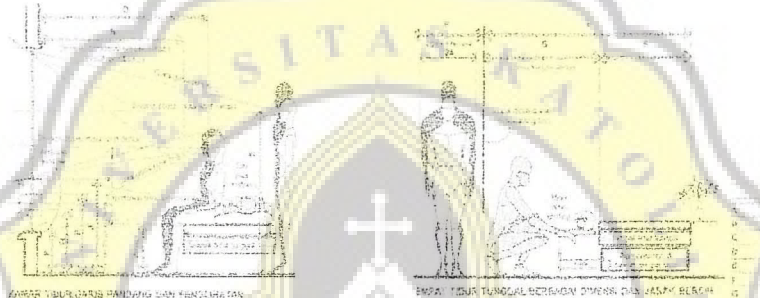

TEMPAT TIDUR BERBAGAI DIMENSI DAN JAVAN BERDIRI

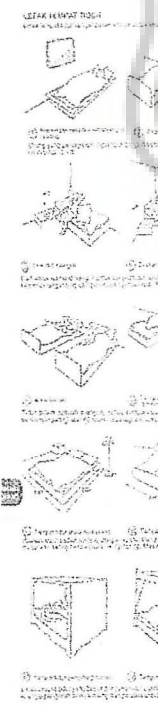

MALUKU GLOSEY DAN FASILITAS PENYIMPANAN

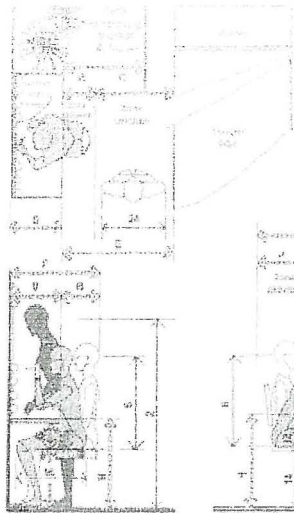

MEJA RIAS



MEJA RIAS ATAU MEJA TULUS

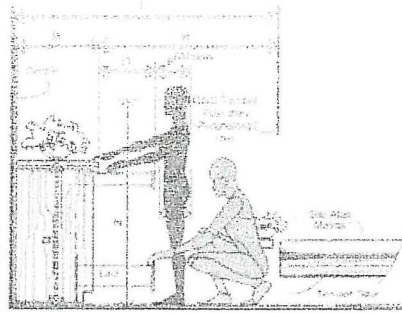

TEMPAT DUDUK/LEMARI RIAS JARAK BERSIH

Letter	Value	Unit
A	120-130	cm
B	120-130	cm
C	120-130	cm
D	120-130	cm
E	120-130	cm
F	120-130	cm
G	120-130	cm
H	120-130	cm
I	120-130	cm
J	120-130	cm
K	120-130	cm
L	120-130	cm
M	120-130	cm
N	120-130	cm
O	120-130	cm
P	120-130	cm
Q	120-130	cm
R	120-130	cm
S	120-130	cm
T	120-130	cm
U	120-130	cm
V	120-130	cm
W	120-130	cm
X	120-130	cm
Y	120-130	cm
Z	120-130	cm

RUANG LINGKUP KEMUKAAN

Sumber :

- Data Arsitek
- Dimensi manusia dan Ruang Interior

## 2. Ruang Duduk

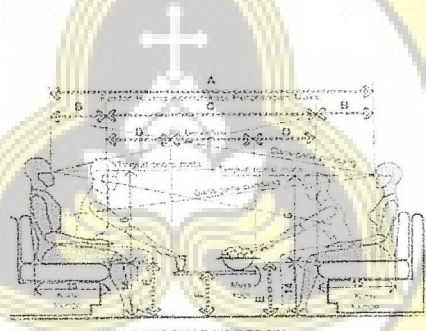
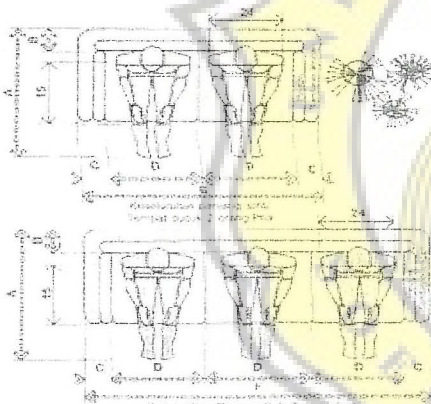

TEMPAT DUDUK LOUNGE JARAK BERSIH  
TEMPAT DUDUK LOUNGE HUBUNGAN JARAK BERSIH

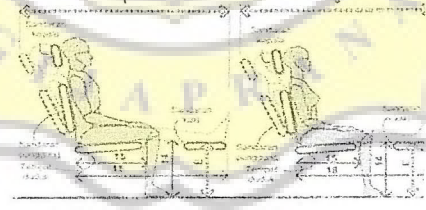
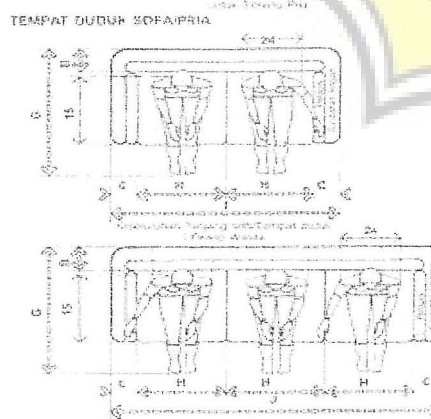
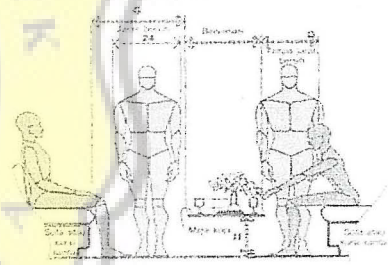

KURSI DENGAN SANDARAN YANG DAPAT DIATUR SERTA SANDARAN KAKI/PRIA DAN WANITA

Letter	Value	Unit
A	84-110	cm
B	13-16	cm
C	53-60	cm
D	19-25	cm
E	14-17	cm
F	19-18	cm
G	11-7%	cm
H	12-15	cm
I	65-68	cm
J	12-12	cm

RUANG LINGKUP KEMUKAAN

TEMPAT DUDUK SOFA/WANITA

Letter	Value	Unit
A	120-130	cm
B	120-130	cm
C	120-130	cm
D	120-130	cm
E	120-130	cm
F	120-130	cm
G	120-130	cm
H	120-130	cm
I	120-130	cm
J	120-130	cm

RUANG LINGKUP KEMUKAAN

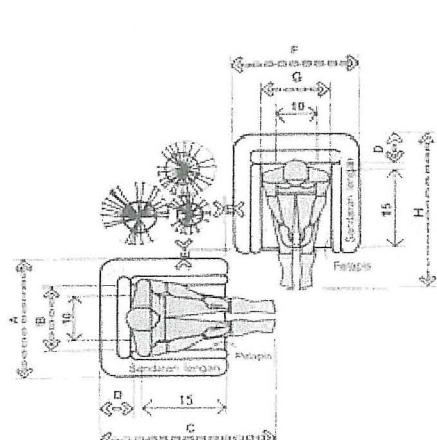

TEMPAT DUDUK KURSI DI SUDUT LOUNGE PRIA DAN WANITA

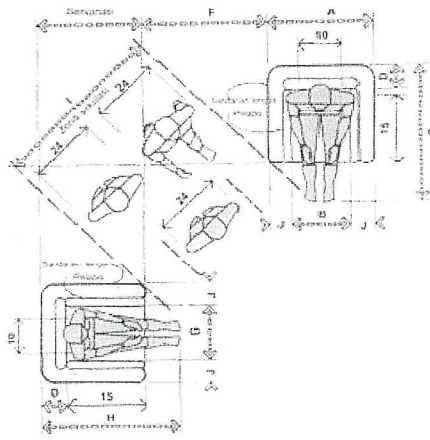

TEMPAT DUDUK DI SUDUT LOUNGE DENGAN SIRKULASI

	m	cm
A	34-40	86.4-101.6
B	23	58.4
C	42-48	106.7-121.9
D	6-9	15.2-22.9
E	3	7.6
F	32-38	81.3-96.5
G	20	50.8
H	40-45	101.6-114.3
I	48-60	121.9-152.4
J	3-6	7.6-15.2

RUANG-RUANG MUKAN 135

### 3. Ruang Makan

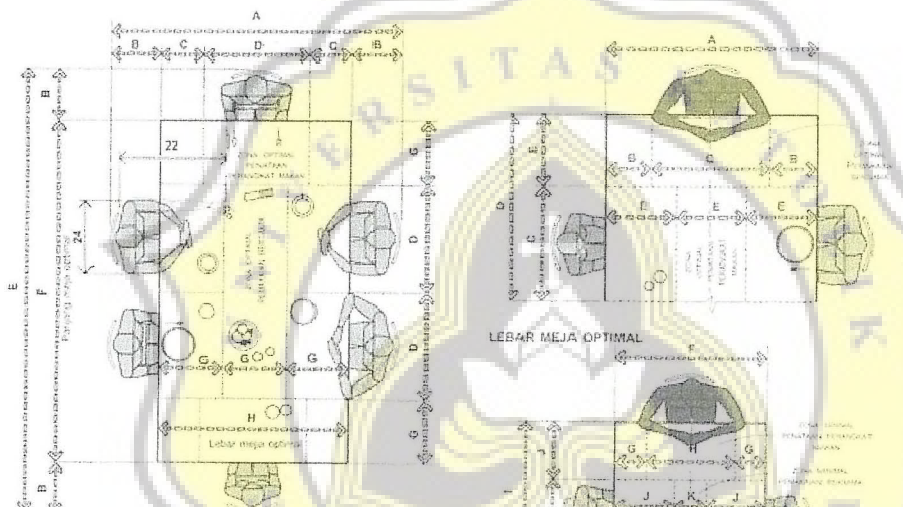

MEJA PERSEGI/PANJANG DAN LEBAR OPTIMAL/UNTUK ENAM ORANG

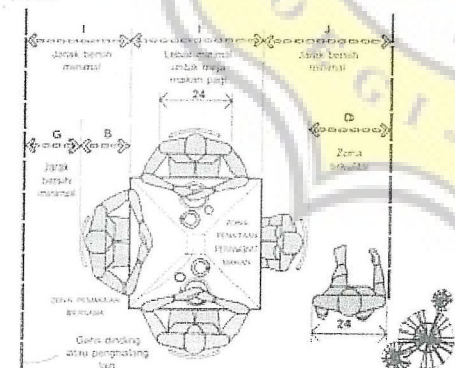

MEJA DAPUR/KEGIATAN MAKAN PAGI/UNTUK EMPAT ORANG

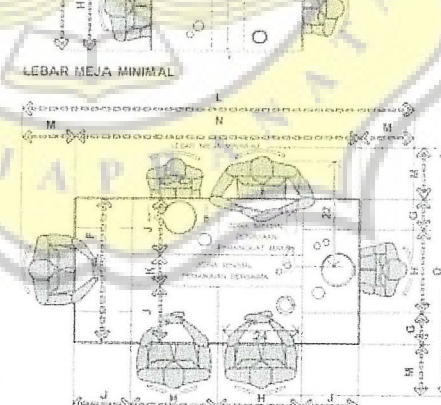

MEJA PERSEGI/PANJANG DAN LEBAR MINIMAL/UNTUK ENAM ORANG

	m	cm
A	54	137.2
B	42	106.5
C	50	126.5
D	48	121.9
E	18	45.7
F	42	106.7
G	9	22.9
H	24	61.0
I	40	101.6
J	16	40.6
K	10	25.4
L	116-128	294.3-325.1
M	13-24	48.7-61.0
N	80	203.2
O	70-90	177.8-228.6

RUANG-RUANG MUKAN 141



## 4. Dapur

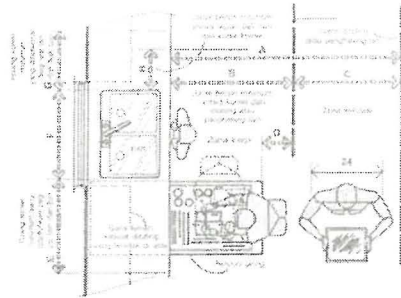

PUSAT DAERAH CUCI

	SI	SD
A	60-65	112,4-127,6
B	80-85	121,3-136,5
C	40-50	81,0-101,4
D	40	81,3
E	40	81,3
F	120-130	243,0-261,0
G	30-35	60,0-70,5
H	70-80	140,0-161,0
I	50	101,3
J	11,5	23,0
K	20-25	40,0-50,5
L	15-20	30,3-40,7
M	10	20,3
N	35-40	70,5-81,0
O	30-35	60,6-76,5

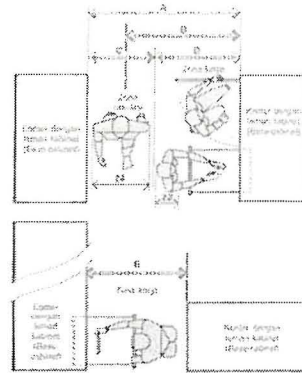

KERTOR DAS LEMBAR KABINET (DAS CAKUPAN) JARAK BERSIH UMUM

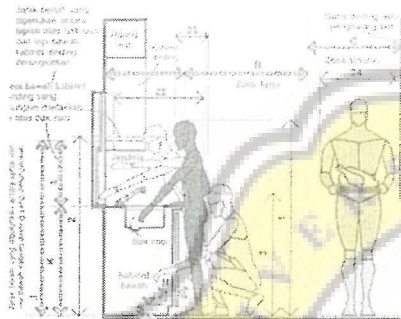

PUSAT DAERAH CUCI

	SI	SD
1	70-75	140,0-157,5
2	80	161,0
3	50-55	101,3-111,8
4	10	20,3
5	20-25	40,0-50,5
6	30-35	60,0-70,5
7	40	81,3
8	50	101,3
9	60	121,3
10	70	141,3
11	80	161,3
12	90	181,3
13	100	201,3
14	110	221,3
15	120	241,3
16	130	261,3
17	140	281,3
18	150	301,3
19	160	321,3
20	170	341,3
21	180	361,3
22	190	381,3
23	200	401,3
24	210	421,3
25	220	441,3
26	230	461,3
27	240	481,3
28	250	501,3
29	260	521,3
30	270	541,3
31	280	561,3
32	290	581,3
33	300	601,3
34	310	621,3
35	320	641,3
36	330	661,3
37	340	681,3
38	350	701,3
39	360	721,3
40	370	741,3
41	380	761,3
42	390	781,3
43	400	801,3
44	410	821,3
45	420	841,3
46	430	861,3
47	440	881,3
48	450	901,3
49	460	921,3
50	470	941,3
51	480	961,3
52	490	981,3
53	500	1001,3
54	510	1021,3
55	520	1041,3
56	530	1061,3
57	540	1081,3
58	550	1101,3
59	560	1121,3
60	570	1141,3
61	580	1161,3
62	590	1181,3
63	600	1201,3
64	610	1221,3
65	620	1241,3
66	630	1261,3
67	640	1281,3
68	650	1301,3
69	660	1321,3
70	670	1341,3
71	680	1361,3
72	690	1381,3
73	700	1401,3
74	710	1421,3
75	720	1441,3
76	730	1461,3
77	740	1481,3
78	750	1501,3
79	760	1521,3
80	770	1541,3
81	780	1561,3
82	790	1581,3
83	800	1601,3
84	810	1621,3
85	820	1641,3
86	830	1661,3
87	840	1681,3
88	850	1701,3
89	860	1721,3
90	870	1741,3
91	880	1761,3
92	890	1781,3
93	900	1801,3
94	910	1821,3
95	920	1841,3
96	930	1861,3
97	940	1881,3
98	950	1901,3
99	960	1921,3
100	970	1941,3
101	980	1961,3
102	990	1981,3
103	1000	2001,3
104	1010	2021,3
105	1020	2041,3
106	1030	2061,3
107	1040	2081,3
108	1050	2101,3
109	1060	2121,3
110	1070	2141,3
111	1080	2161,3
112	1090	2181,3
113	1100	2201,3
114	1110	2221,3
115	1120	2241,3
116	1130	2261,3
117	1140	2281,3
118	1150	2301,3
119	1160	2321,3
120	1170	2341,3
121	1180	2361,3
122	1190	2381,3
123	1200	2401,3
124	1210	2421,3
125	1220	2441,3
126	1230	2461,3
127	1240	2481,3
128	1250	2501,3
129	1260	2521,3
130	1270	2541,3
131	1280	2561,3
132	1290	2581,3
133	1300	2601,3
134	1310	2621,3
135	1320	2641,3
136	1330	2661,3
137	1340	2681,3
138	1350	2701,3
139	1360	2721,3
140	1370	2741,3
141	1380	2761,3
142	1390	2781,3
143	1400	2801,3
144	1410	2821,3
145	1420	2841,3
146	1430	2861,3
147	1440	2881,3
148	1450	2901,3
149	1460	2921,3
150	1470	2941,3
151	1480	2961,3
152	1490	2981,3
153	1500	3001,3
154	1510	3021,3
155	1520	3041,3
156	1530	3061,3
157	1540	3081,3
158	1550	3101,3
159	1560	3121,3
160	1570	3141,3
161	1580	3161,3
162	1590	3181,3
163	1600	3201,3
164	1610	3221,3
165	1620	3241,3
166	1630	3261,3
167	1640	3281,3
168	1650	3301,3
169	1660	3321,3
170	1670	3341,3
171	1680	3361,3
172	1690	3381,3
173	1700	3401,3
174	1710	3421,3
175	1720	3441,3
176	1730	3461,3
177	1740	3481,3
178	1750	3501,3
179	1760	3521,3
180	1770	3541,3
181	1780	3561,3
182	1790	3581,3
183	1800	3601,3
184	1810	3621,3
185	1820	3641,3
186	1830	3661,3
187	1840	3681,3
188	1850	3701,3
189	1860	3721,3
190	1870	3741,3
191	1880	3761,3
192	1890	3781,3
193	1900	3801,3
194	1910	3821,3
195	1920	3841,3
196	1930	3861,3
197	1940	3881,3
198	1950	3901,3
199	1960	3921,3
200	1970	3941,3
201	1980	3961,3
202	1990	3981,3
203	2000	4001,3
204	2010	4021,3
205	2020	4041,3
206	2030	4061,3
207	2040	4081,3
208	2050	4101,3
209	2060	4121,3
210	2070	4141,3
211	2080	4161,3
212	2090	4181,3
213	2100	4201,3
214	2110	4221,3
215	2120	4241,3
216	2130	4261,3
217	2140	4281,3
218	2150	4301,3
219	2160	4321,3
220	2170	4341,3
221	2180	4361,3
222	2190	4381,3
223	2200	4401,3
224	2210	4421,3
225	2220	4441,3
226	2230	4461,3
227	2240	4481,3
228	2250	4501,3
229	2260	4521,3
230	2270	4541,3
231	2280	4561,3
232	2290	4581,3
233	2300	4601,3
234	2310	4621,3
235	2320	4641,3
236	2330	4661,3
237	2340	4681,3
238	2350	4701,3
239	2360	4721,3
240	2370	4741,3
241	2380	4761,3
242	2390	4781,3
243	2400	4801,3
244	2410	4821,3
245	2420	4841,3
246	2430	4861,3
247	2440	4881,3
248	2450	4901,3
249	2460	4921,3
250	2470	4941,3
251	2480	4961,3
252	2490	4981,3
253	2500	5001,3
254	2510	5021,3
255	2520	5041,3
256	2530	5061,3
257	2540	5081,3
258	2550	5101,3
259	2560	5121,3
260	2570	5141,3
261	2580	5161,3
262	2590	5181,3
263	2600	5201,3
264	2610	5221,3
265	2620	5241,3
266	2630	5261,3
267	2640	5281,3
268	2650	5301,3
269	2660	5321,3
270	2670	5341,3
271	2680	5361,3
272	2690	5381,3
273	2700	5401,3
274	2710	5421,3
275	2720	5441,3
276	2730	5461,3
277	2740	5481,3
278	2750	5501,3
279	2760	5521,3
280	2770	5541,3
281	2780	5561,3
282	2790	5581,3
283	2800	5601,3
284	2810	5621,3
285	2820	5641,3
286	2830	5661,3
287	2840	5681,3
288	2850	5701,3
289	2860	5721,3
290	2870	5741,3
291	2880	5761,3
292	2890	5781,3
293	2900	5801,3
294	2910	5821,3
295	2920	5841,3
296	2930	5861,3
297	2940	5881,3
298	2950	5901,3
299	2960	5921,3
300	2970	5941,3
301	2980	5961,3

# 6. Kantor Pengelola

**MEJA TULIS EKSEKUTIF/TEMPAT DUDUK TAMU**

**ALAS MEJA KETIK DAN MEJA TULIS/PEMAGAS PISA**

**POS KERJA YANG BERKONFIGURASI SIKAP BERBENTUK SANGI**

**MEJA TULIS EKSEKUTIF/JARAK BERSIH DASAR**

**POS KERJA BERBENTUK SANGI 'B'**

**POS KERJA YANG BERKONFIGURASI SIKAP BERBENTUK 'B'**

**POS KERJA BERBENTUK TEMPAT DUDUK/PEMAGAS AIRUP TERJEMPAH YANG TERLETAK DI DELAPAN**

**POS KERJA DASAR DENGAN TEMPAT DUDUK TAMU**

**POS KERJA DASAR DENGAN TEMPAT DUDUK TAMU**

**POS KERJA DASAR DENGAN TEMPAT DUDUK TAMU**

	SI	SI*
A	100-105	101.5-103.5
B	70-75	71.5-73.5
C	50-55	51.5-53.5
D	25-30	26.5-28.5
E	120-125	121.5-123.5
F	80-85	81.5-83.5
G	15-20	16.5-18.5
H	25-30	26.5-28.5
I	15-20	16.5-18.5
J	40-45	41.5-43.5
K	50-55	51.5-53.5

  

	SI	SI*
A	100-105	101.5-103.5
B	70-75	71.5-73.5
C	50-55	51.5-53.5
D	25-30	26.5-28.5
E	120-125	121.5-123.5
F	80-85	81.5-83.5
G	15-20	16.5-18.5
H	25-30	26.5-28.5
I	15-20	16.5-18.5
J	40-45	41.5-43.5
K	50-55	51.5-53.5





## 9. Receptionist

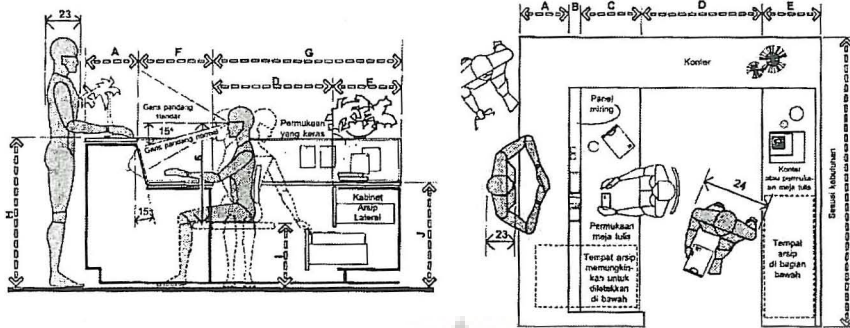

## 10. Ruang rapat

