

# LAMPIRAN

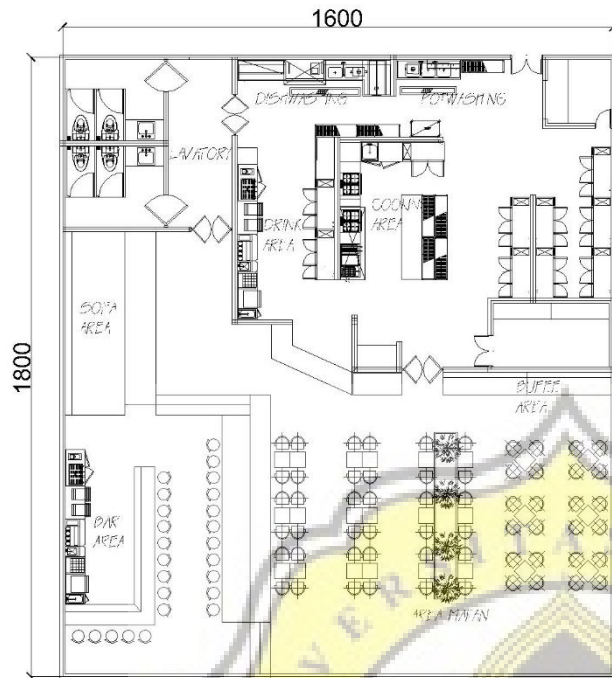

CAFETERIA

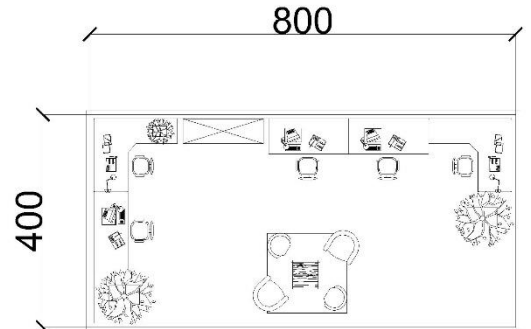

R. ANIMASI

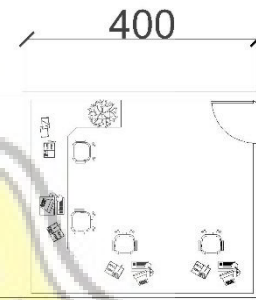

R. PREVIEW & QUALITY CONTROL

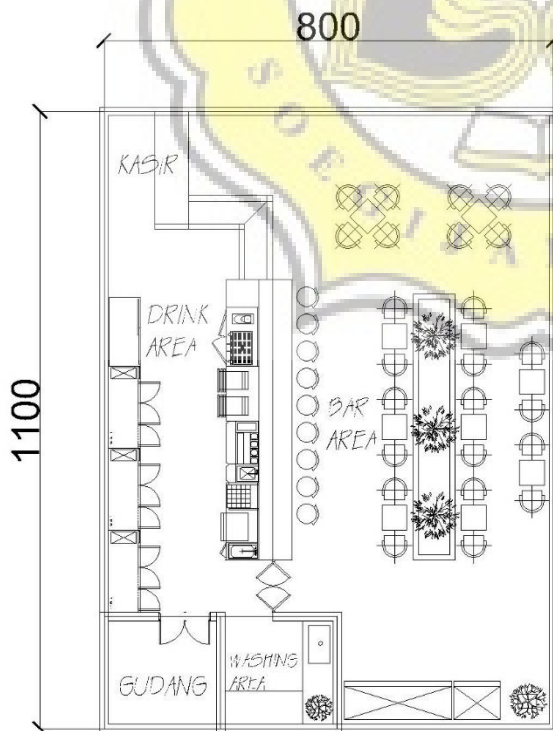

CAFE

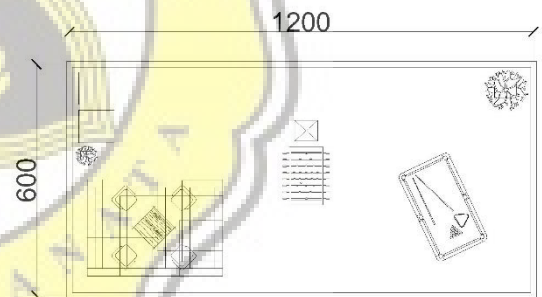

BREAK ROOM

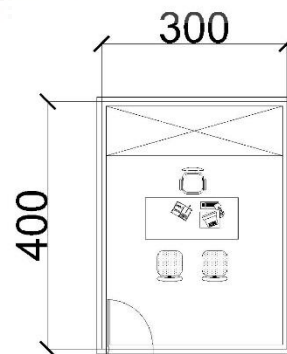

R. MANAGER & KETUA DIVISI

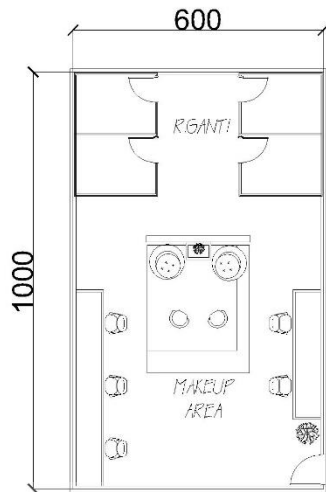

R. GANTI & MAKEUP

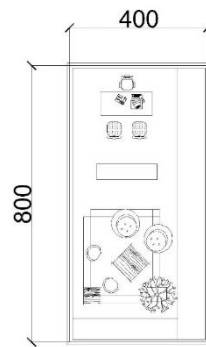

R. DIREKTUR

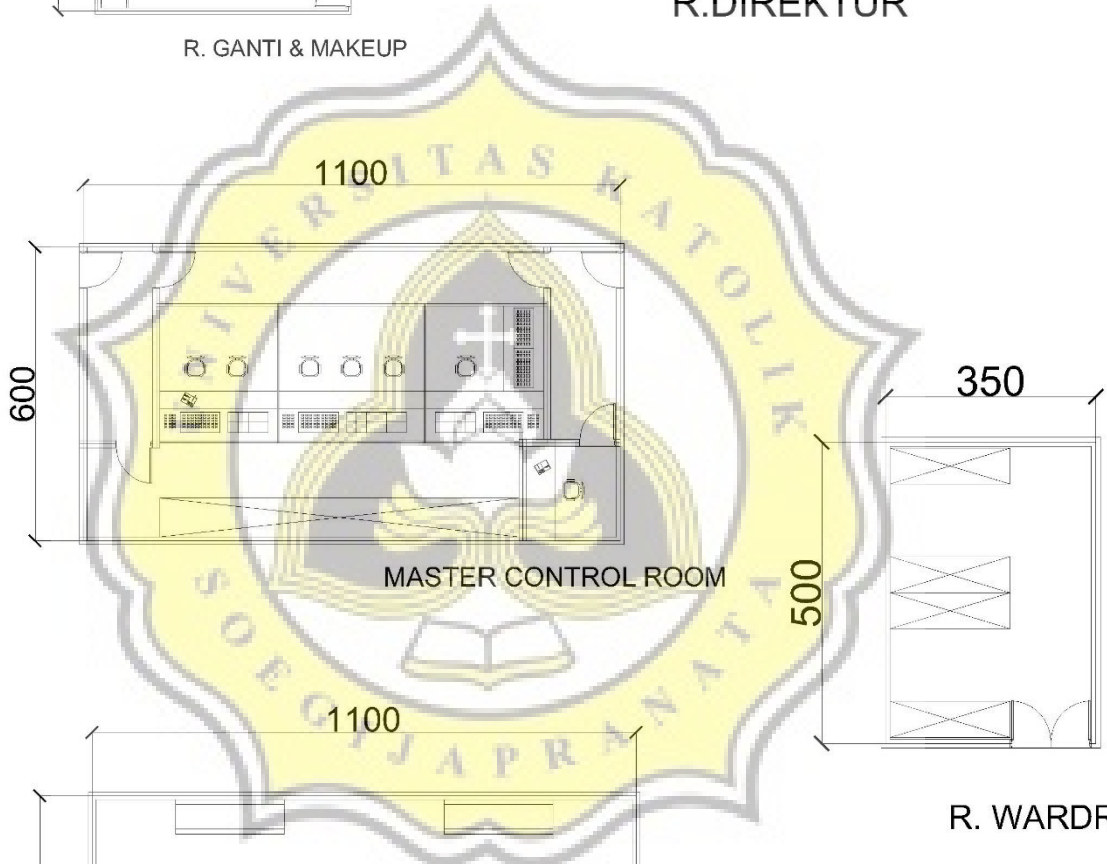

R. WARDROBE

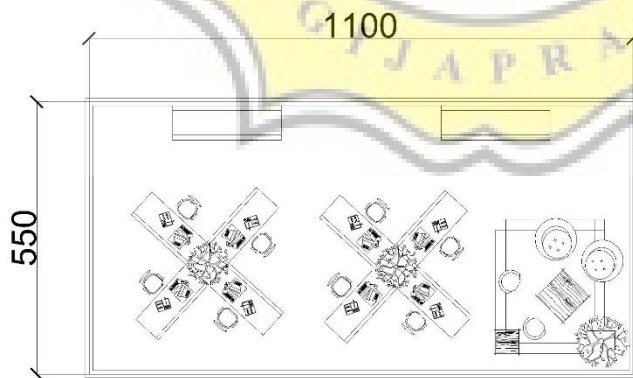

PRIVATE OFFICE

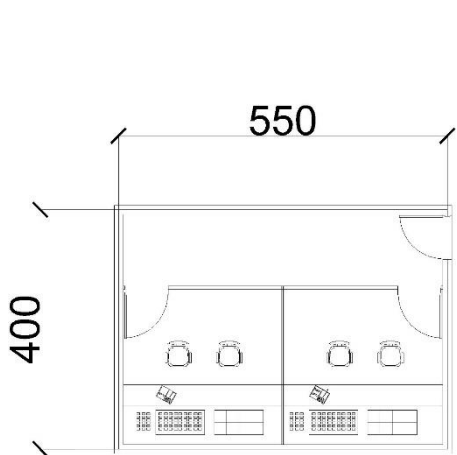

SUB CONTROL ROOM

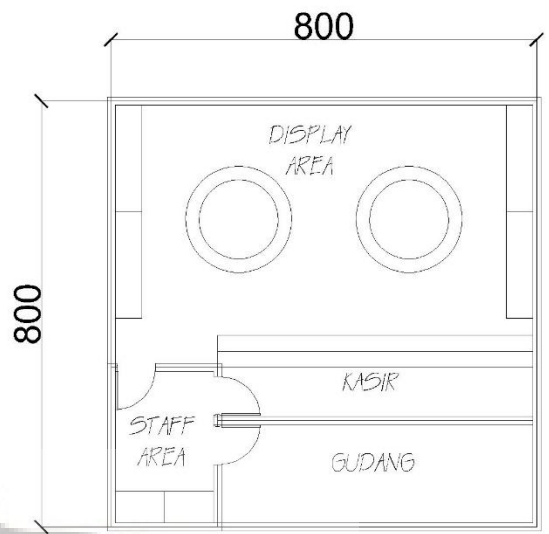

SOUVENIR STORE

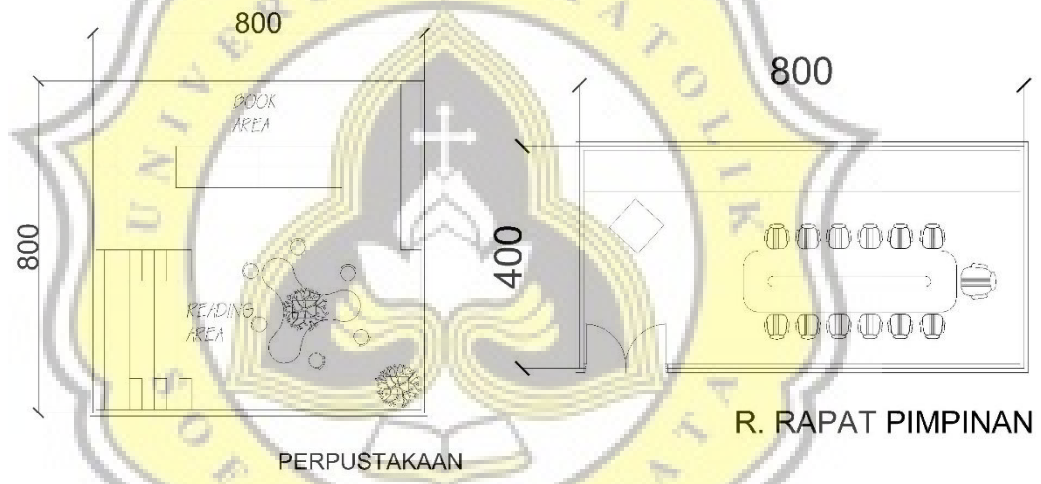

PERPUSTAKAAN

R. RAPAT PIMPINAN

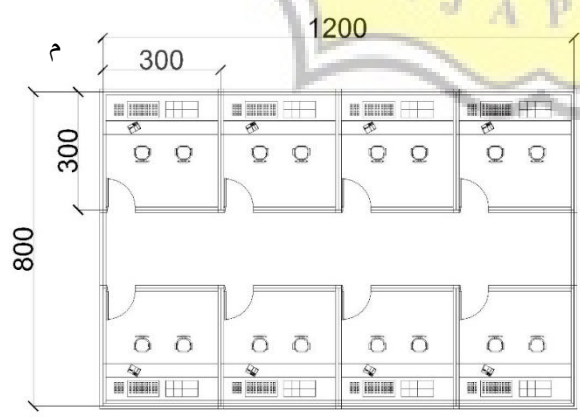

R. EDITING

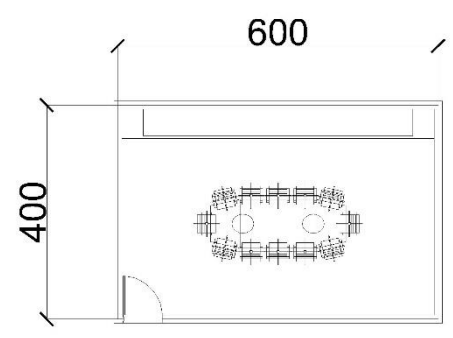

R. RAPAT KECIL

## HASIL PEMERIKSAAN PLAGSCAN

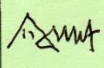
8.840 

**FORMULIR SCAN ANTI PLAGIARISME**

Nama : ANHISA RADITA PUSPITA HING TYAS

Alamat email : TYAS.RADITA@gmail.com

Fak. / Prodi : FAD ARSITEKTUR NIM: 13.11.0085

berupa ( TESIS, TUGAS AKHIR, SKRIPSI, SUMMARY, LAPORAN KERJA PRAKTEK )

dengan judul : GEDUNG PENYIARAN STASIUN TELEVISI  
NASIONAL ANAK DI JAKARTA.

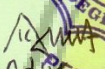
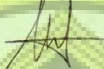
Semarang, Petugas  Yang Menyerahkan, Dosen Pembimbing, 

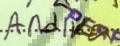
 ANHISA 

NB. Laporan hasil scan terlampir  untuk Yang bersangkutan \*

