



LAMPIRAN



STUDI RUANG

UNIT KANTOR SEWA

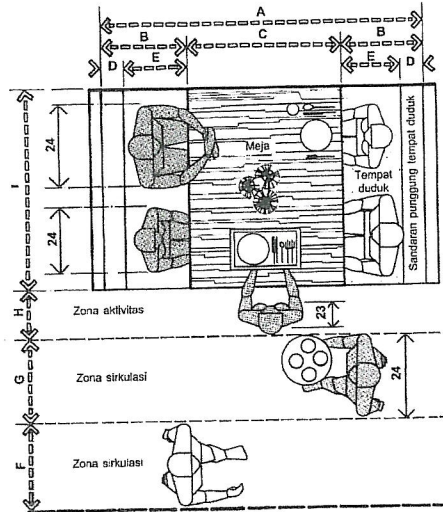

TEMPAT DUDUK STAN DAN JARAK BERSIH SIRKULASI

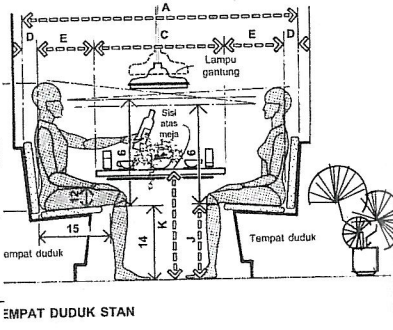

EMPAT DUDUK STAN

	in	cm
A	65-80	165,1-203,2
B	17,5-20	44,5-50,8
C	30-40	76,2-101,6
D	2-4	5,1-10,2
E	15,5-16	39,4-40,6
F	30	76,2
G	36	91,4
H	18	45,7
I	48-54	121,9-137,2
J	16-17	40,6-43,2
K	29-30	73,7-76,2

232 RUANG INTERIOR/STANDAR PERAN

KANTOR SEWA

KANTOR SEWA

KANTOR SEWA

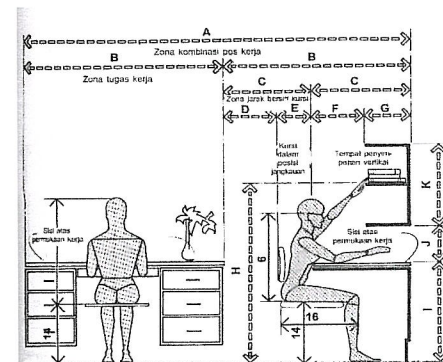

POS KERJA DASAR DENGAN TEMPAT PENYIMPAN VERTIKAL

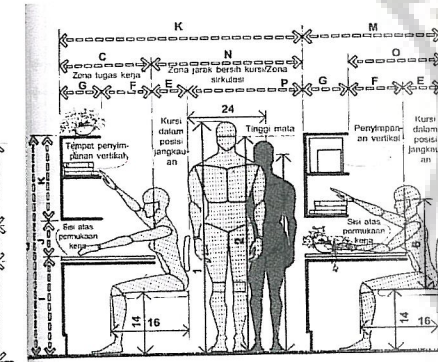

POS KERJA DASAR YANG SALING MEMBELAKANGI DENGAN TEMPAT PENYIMPAN VERTIKAL

	in	cm
A	120-144	304,8-365,8
B	60-72	152,4-182,9
C	30-36	76,2-91,4
D	18-20	45,7-50,8
E	12-16	30,5-40,6
F	18-24	45,7-61,0
G	12	30,5
H	53-58	134,8-147,3
I	29-30	73,7-76,2
J	15 min	38,1 min
K	25-31	63,5-78,7
L	78-94	198,1-239,8
M	42-52	106,7-132,1
N	48-58	121,9-147,3
O	30-40	76,2-101,6
P	36-42	91,4-106,7
Q	69-76	175,3-193,0

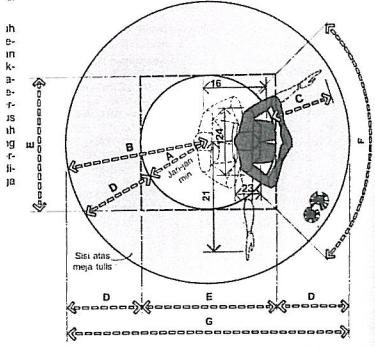

POS KERJA PENERIMA TAMU BERBENTUK BUNDAK

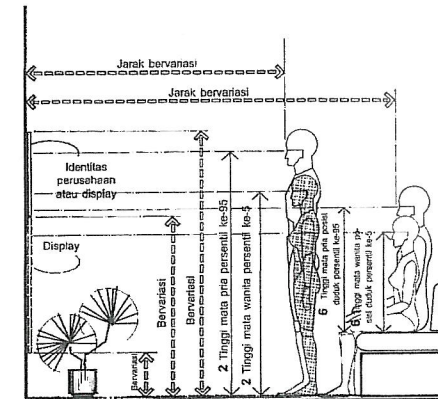

HUBUNGAN-HUBUNGAN DISPLAY/VISUAL

	in	cm
A	22	55,9
B	46-52	116,8-132,1
C	18-22	45,7-56,9
D	24-30	61,0-76,2
E	44	111,8
F	76	193,0
G	92-104	233,7-264,2

KANTOR SEWA

Restaurant

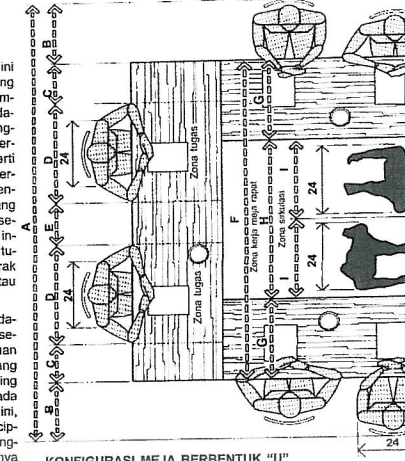

KONFIGURASI MEJA BERBENTUK "U"

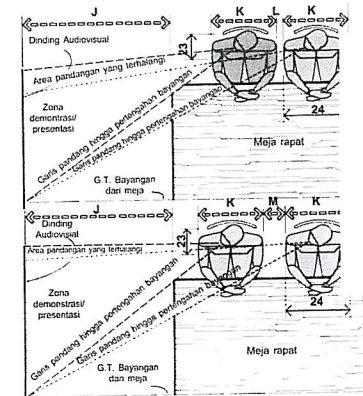

FIGURASI MEJA RAPAT AUDIOVISUAL DAN GARIS PANDANG

	in	cm
A	138-180	350,5-457,2
B	18-24	45,7-61,0
C	12-21	30,5-53,3
D	32-36	81,3-91,4
E	14-18	35,6-45,7
F	108-132	274,3-335,3
G	24-36	61,0-91,4
H	60	152,4
I	30	76,2
J	72	182,9
K	24-28	61,0-71,1
L	3-6	7,6-15,2
M	12-16	30,5-40,6

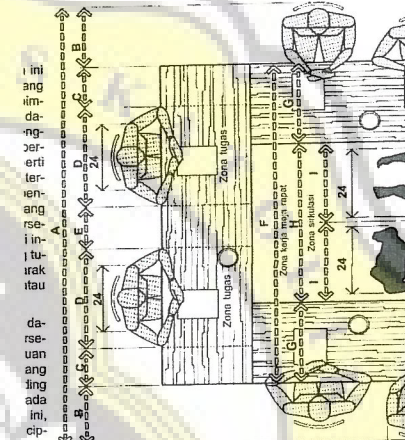

KONFIGURASI MEJA BERBENTUK "U"

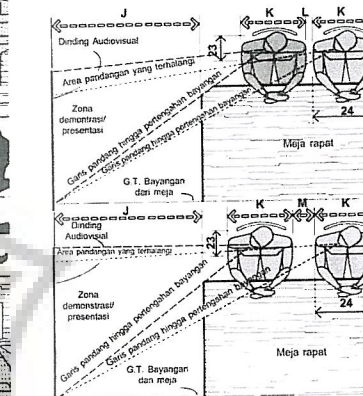

FIGURASI MEJA RAPAT AUDIOVISUAL DAN GARIS PANDANG

	in	cm
A	138-180	350,5-457,2
B	18-24	45,7-61,0
C	12-21	30,5-53,3
D	32-36	81,3-91,4
E	14-18	35,6-45,7
F	108-132	274,3-335,3
G	24-36	61,0-91,4
H	60	152,4
I	30	76,2
J	72	182,9
K	24-28	61,0-71,1
L	3-6	7,6-15,2
M	12-16	30,5-40,6

Poliklinik

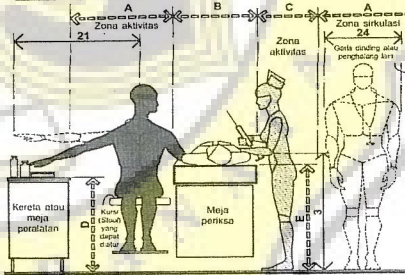

AREA PEMERIKSAAN/JANGKAUAN DAN JARAK BERSIH

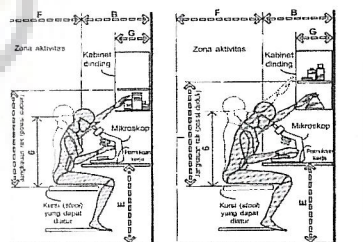

AREA LABORATORIUM/STIMBIANGAN ATAS BLOKOK WANITA

AREA LABORATORIUM/STIMBIANGAN ATAS KELOMPOK PRIA

	in	cm
A	30	76,2
B	24	61,0
C	18	45,7
D	30-36	76,2-91,4
E	34-38	86,4-96,5
F	27	68,6
G	12-15	30,5-38,1
H	39 maks.	99,1 maks.
I	42 maks.	106,7 maks.

Joint Workstation

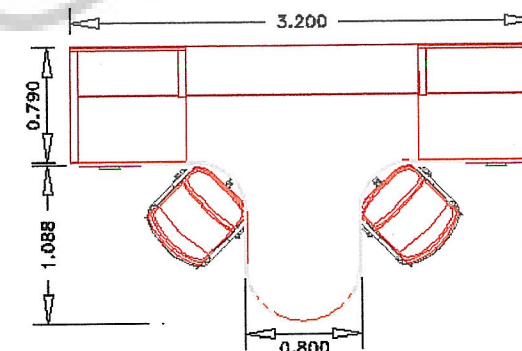

Julius Panero & Martin Zelnik, (2003), Dimensi Manusia dan Interior, Jakarta, Erlangga.

TABEL
PERKIRAAN TINGGI ELEMEN STRUKTUR HORIZONTAL DENGAN
BENTANGAN

TABEL 3.7 Dimensi Perkiraan Nisbah Tinggi Elemen Struktur Horizontal dengan Bentangan

Jenis Elemen Struktur	Rata-rata C_m	Maksimum C_m	Bentang Tipikal (m)
Beton Bertulang:			
- Pelat masif	28	32	3 - 8
- Pelat dua arah	30	36	7 - 12
- Pelat wafel	20	24	10 - 14
- Rusuk	22	26	8 - 15
- Balok anak	16	20	5 - 14
- Balok induk	12	16	7 - 20
- Balok tertekuk (tidak lurus)	24	30	14 - 28
- Balok busur			
tinggi lengkungan	8	12	20 - 50
tinggi balok	30	40	
Baja:			
- Pelat dan Balok - I	18	24	5 - 20
- Rangka Batang Bidang	14	20	14 - 35
- Balok tertekuk (tidak lurus)	30	40	17 - 40
- Balok busur			
tinggi lengkungan	8	16	27 - 68
tinggi balok	40	50	
Beton Pra-Tegang:			
- Pelat masif	40	44	7 - 12
- Pelat dua arah	44	48	12 - 15
- Pelat wafel	28	32	12 - 24
- Pelat berongga	36	40	10 - 20
- Rusuk	32	36	14 - 20
- Balok anak	24	28	10 - 28
- Balok induk	20	24	14 - 30

Sumber : Ir .Hartono Poerbo,(1998),Tekno Ekonomi Bangunan Bertingkat Banyak,Jakarta ,Djambatan.

REKAPITULASI VOLUME PRODUKSI / INVESTASI / T.
KERJA
INDUSTRI MENENGAH :

NO	PRODUK INDUSTRI	JUMLAH U. USAHA	VOLUME PRODUKSI	SATUAN	INVESTASI (000)	T. KERJA
1	2	3	4	5	6	7
A	IND. KIMIA , AGRO , HASIL HUTAN					
	DAN KERTAS / PULP (IKAH) :					
	Kimia dan barang kimia :					
1	BARANG PLASTIK	17			17.250,24	2.606
2	BARANG KIMIA	19			24.799.190,00	2.032
3	BHN BANGUNAN DARI SEMEN	8			17.689.240,00	790
4	KAPUR BARUS					
5	KOSMETIK					
6	BATA MERAH					
7	OBAT GOSOK DAN LAINNYA					
	Minuman :					
8	MINUMAN	54			10.005.572,47	2.998
9	ROKOK DAN CENGKEH	14	6.536.950.000	BT	4.144.062,57	6.392
10	SIRUP					
11	AMDK					
12	DEPOT AIR MINUM ISI ULANG					
	Makanan :					
13	MAKANAN	59			10.426.605,69	329
14	PENGOLAHAN IKAN					
15	SAMBAL SAOS					
16	MIE BASAH KERING					
17	WINGKO					
18	TEMPE					
19	KRUPUK TERUNG					
20	KECAP					
21	KEMBANG GULA					
22	ROTI BASAH					
23	PENGAWETAN SAYUR					
	Ind. Pengolahan Hasil hutan :					
24	MEBEL/ FURNITURE	1	600	M3	350.000,00	37
25	PENGOLAHAN	138				8.173

	KAYU				12.988.181,18	
26	KARET	11			3.654.220,00	2.558
Kulit dan barang dari kulit :						
27	KULIT	6			9.515,87	
28	INDUSTRI KULIT & BRG DR KULIT	6			9.515.870,00	2.227
Percetakan kertas dan pulp :						
29	PERCETAKAN	102			5.005.334,92	4.220
B IND. LOGAM, MESIN, ELEKTRONIKA DAN ANEKA (ILMEA) :						
Logam						
30	LOGAM & MESIN	39			13.898.199,00	5.621
31	PERBENGKELAN	50			41.850,69	3.333
32	BENGKEL LAS					
33	TIMBANGAN					
34	BENGKEL KONSTRUKSI					
35	BARANG KALENG					
36	TIMAH BATANGAN					
37	PERHIASAN LOGAM MULIA					
38	KOMP. ONDERDIL KENDARAAN					
39	ONDERDIL KELOMPOK INDUSTRI					
Elektronika :						
40	ELEKTRONIK	16			11.739,88	1.240
41	REKAMAN SUARA					
Alat angkut :						
42	ALAT ANGKUT	2	32.700	UNIT	1.059.000,00	55
Aneka :						
43	BATU BARA BRIKET	2			1.005.000,00	
44	TEKSTIL	49			133.284,99	
45	SPRING BED	1	3.600	BUAH	80.000,00	
TOTAL		594			114.834.117,50	57.241

REKAPITULASI VOLUME / INVESTASI / T. KERJA IZIN USAHA INDUSTRI (IUI) BESAR :

NO	PRODUK INDUSTRI	JUMLAH U. USAHA	VOLUME PRODUKSI	SATUAN	INVESTASI (Juta)	T. KERJA
1	2	3	4	5	6	7
A						
IND. KIMIA, AGRO, HASIL HUTAN DAN PERCETAKAN / PULP (IKAH)						
Kimia dan barang kimia :						
1	BARANG2 KIMIA	6			1.793,58	196
2	PLASTIK	6			16.730,62	2.849
3	KAPUR BARUS					
4	KOSMETIK					
5	BHN BANGUNAN DARI SEMEN					
6	BATA MERAH					
7	OBAT GOSOK DAN LAINNYA					
Minuman :						
8	MINUMAN JAMU ROKOK DAN CENGKEH	11			16.500,00	1.160
9		4			622.433,51	5.091
10	SIRUP					
11	MINUMAN RINGAN					
12	AMDK					
13	DEPOT AIR MINUM ISI ULANG					
Makanan :						
14	MAKANAN	9			35.500,00	2.135
15	PENGOLAHAN IKAN					
16	SAMBAL SAOS					
17	MIE BASAH KERING					
18	WINGKO	40				
19	TEMPE					
20	KRUPUK TERUNG	14.577				
21	KECAP					
22	KEMBANG GULA	13				
23	ROTI BASAH					
24	PENGAWETAN SAYUR					
Industri pengolahan hasil hutan :						

LAMPIRAN

	25	PENGOLAHAN KAYU	16		47.260,00	4.660
	26	KARET DAN BARANG DARI KARET	4		40.763,00	288
	27	MEBEL/ FURNITURE				
	28	BAHAN BANGUNAN DARI KAYU				
	Percetakan / kertas dan pulp :					
	29	PERCETAKAN	8		10.110,00	1.390
B.	IND. LOGAM, MESIN, ELEKTRONIKA DAN ANEKA (ILMEA)					
	Logam :					
	30	LOGAM	14		8.590.960,44	3.384
	31	BENGKEL MESIN	2		2.739,90	460
	32	BENGKEL LAS				
	33	TIMBANGAN				
	34	BENGKEL KONSTRUKSI				
	35	BARANG KALENG				
	36	TIMAH BATANGAN				
	37	PERHIASAN LOGAM MULIA				
	38	KOMP. ONDERDIL KENDARAAN				
	39	ONDERDIL KELOMPOK INDUSTRI				
	Elektronika :					
	40	KOMP. ELEKTRONIKA	3		16.500,00	814
	41	REKAMAN SUARA				
	Alat angkut :					
	42	SEPEDA MOTOR / BECAK DLL .	9		7.013,90	460
	Aneka :					
	43	KERAMIK DAN KACA	7		37.500,00	4.700
	44	TEKSTIL DAN BARANG TEKSTIL	18		128.020,38	15.676
	TOTAL					
			117		9.573.825,33	43.263

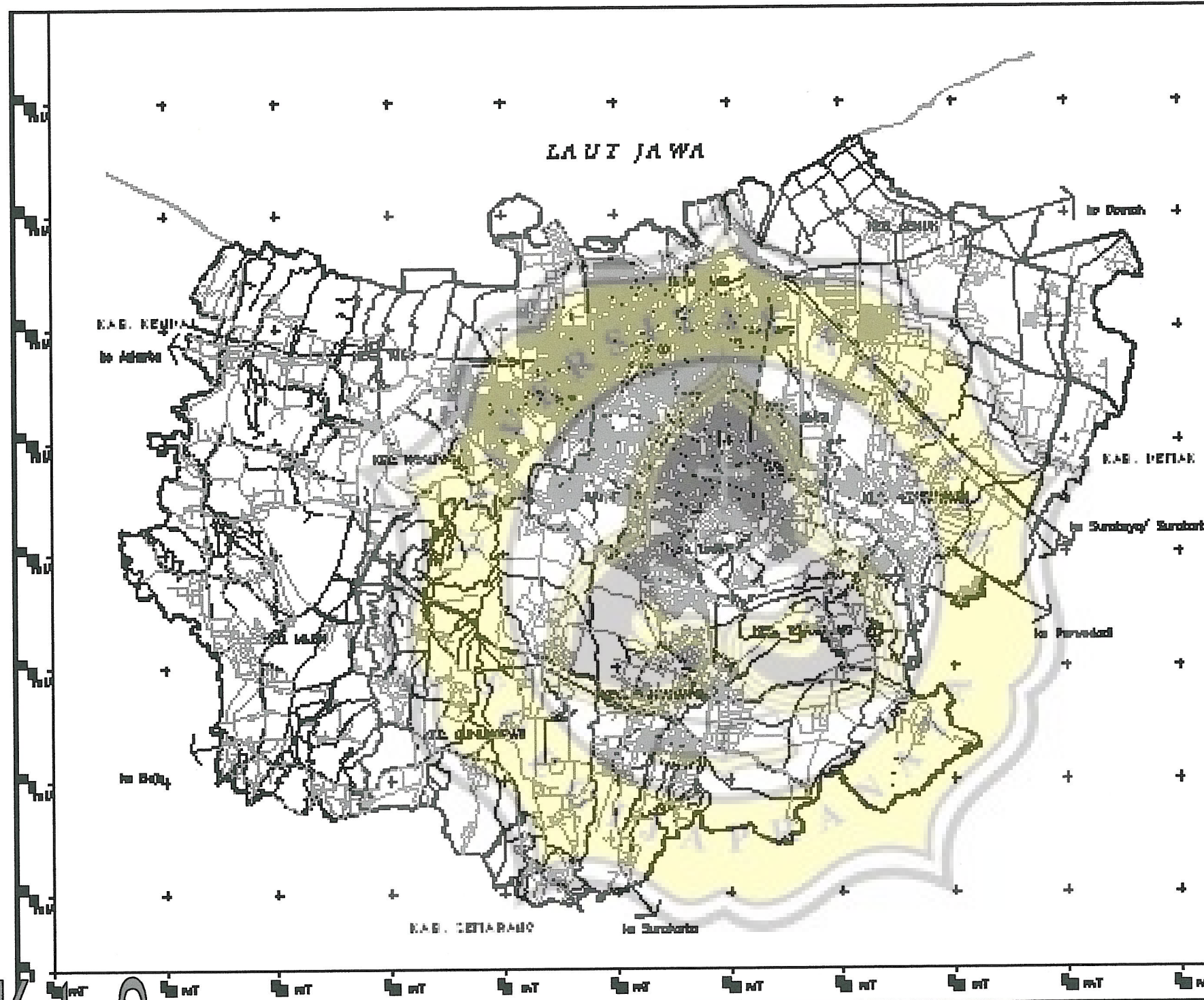

















**PEMERINTAH KOTA
SEMARANG**

REVISI
TAHUN 2000 - 2010

PETA

KETERANGAN

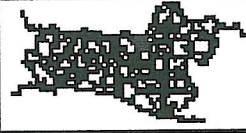
-  : Kota Semarang
-  : Kecamatan
-  : Kelurahan
-  : Bangsal
-  : Jalan
-  : Jalan Utama
-  : Jalan perantara
-  : Jalan sekunder
-  : Rencana jalan utama
-  : Rencana jalan sekunder
-  : Jalan lokal primer
-  : Jalan lokal sekunder
-  : Jalan lokal primer/sekunder

INSET PETA	MERE PETA
	NIL. PETA
SKALA	UTARA
	

PETA Kota Semarang

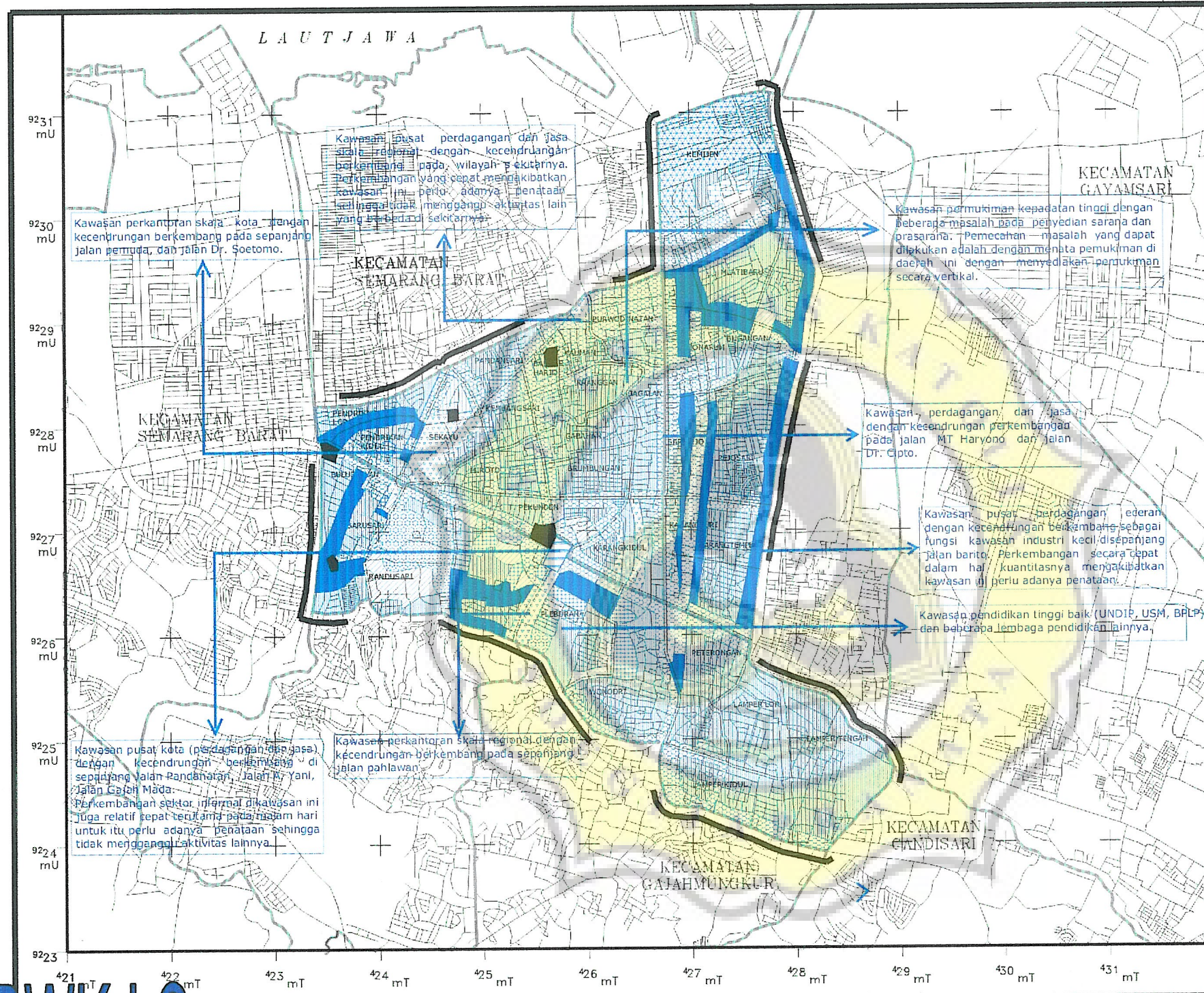

PEMERINTAH KOTA SEMARANG
EVALUASI RDRK SEMARANG
TAHUN 2000 - 2010
PETA

POLA PEMANFAATAN RUANG

KETERANGAN

	: Batas Kota Madya		: Jalan
	: Batas Kecamatan		: Sungai
	: Batas Kelurahan		: Batas BKK
	: Pemukiman		: Transportasi
	: Campuran		: Ruang Terbuka
	: Perdagangan dan jasa		: Industri
	: Perkantoran		: Pergudangan
	: Fas. pendidikan		
	: Fas. kesehatan		
	: Makam		
	: Fas. peribadatan		

INSET PETA	KODE PETA
	
	NO. PETA
SKALA  0 400 800 1600 M	UTARA 
SUMBER	

PETA BWK | Semarang

